

Installation Manual

Table screen Installation

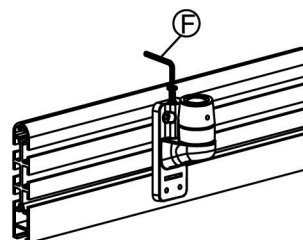

1

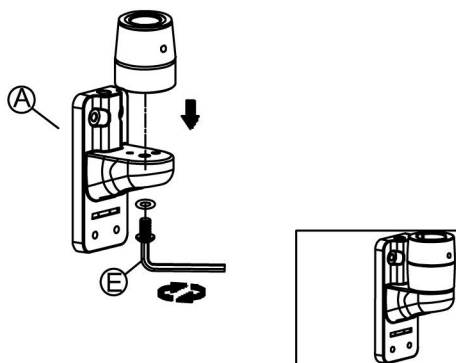
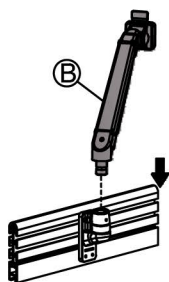

2

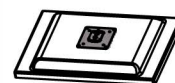
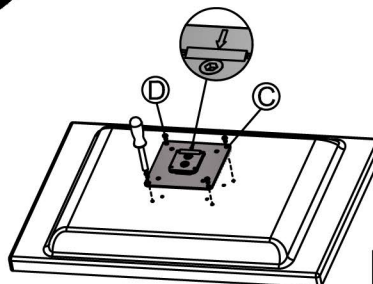

• Please mind the arrow direction.

3

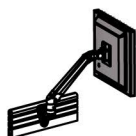
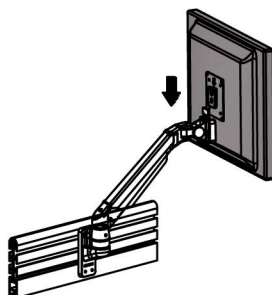

4

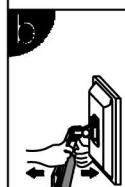
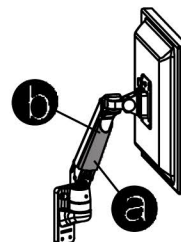

• Please follow a-b-c step to disassemble.

Installation Manual

5

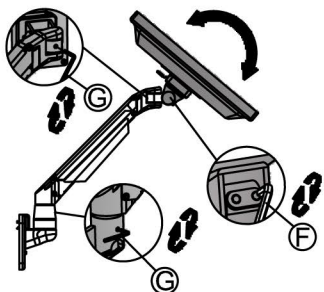



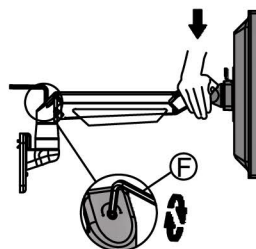



6



• Please keep the forearm level when to adjust pressure.

Parts list

No.	ITEM	SPECS	QUANTITY
A			1
B			1
C			1
D		M4*12	4
E		M6	1
F		M4	1
G		M3	1